

GBM-104-50 (RoHS compliant)
1550 nm Single-mode Transceiver, 20dB margin
Small Form Pluggable (SFP), 3.3V
1.0625Gbd Fiber Channel/1.25 Gigabit Ethernet



	<p>Features</p> <ul style="list-style-type: none"> ■ Compliant with IEEE802.3z Gigabit Ethernet Standard ■ Compliant with Fiber Channel 100-SM-LL-L standard ■ Industry standard small form pluggable (SFP) package ■ Duplex LC connector ■ Differential PECL inputs and outputs ■ Single power supply 3.3V ■ TTL signal detect indicator ■ Hot Pluggable ■ Class 1 laser product complies with EN 60825-1 <p>Application</p> <ul style="list-style-type: none"> ■ Distributed multi-processing ■ Switch to switch interface ■ High speed I/O for file server ■ Bus extension application ■ Channel extender, data storage
--	--

■ **Ordering Information**

PART NUMBER	INPUT/OUTPUT	SIGNAL DETECT	VOLTAGE	TEMPERATURE
GBM-104-50	AC/AC	TTL	3.3V	0°C to 70°C

GBM-104-50 (RoHS compliant)
1550 nm Single-mode Transceiver, 20dB margin
Small Form Pluggable (SFP), 3.3V
1.0625Gbd Fiber Channel/1.25 Gigabit Ethernet

■ **Absolute Maximum Ratings**

PARAMETER	SYMBOL	MIN	MAX	UNITS	NOTE
Storage Temperature	T_S	-40	85	°C	
Supply Voltage	V_{CC}	-0.5	4.0	V	
Input Voltage	V_{IN}	-0.5	V_{CC}	V	
Output Current	I_o	---	50	mA	
Operating Current	I_{OP}	---	400	mA	

■ **Recommended Operating Conditions**

PARAMETER	SYMBOL	MIN	MAX	UNITS	NOTE
Case Operating Temperature	T_C	0	70	°C	GBM-104-50
Supply Voltage	V_{CC}	3.1	3.5	V	
Supply Current	$I_{TX} + I_{RX}$	---	250	mA	

■ **Transmitter Electro-optical Characteristics**

$V_{CC} = 3.1 \text{ V to } 3.5 \text{ V}, T_C = 0 \text{ }^\circ\text{C to } 70 \text{ }^\circ\text{C} (-40 \text{ }^\circ\text{C to } 85 \text{ }^\circ\text{C})$

PARAMETER	SYMBOL	MIN	TYP.	MAX	UNITS	NOTE
Output Optical Power 9/125 μm fiber	P_{out}	-4	---	+1	dBm	Average
Extinction Ratio	ER	7	---	---	dB	
Center Wavelength	λ_C	1530	1550	1570	nm	
Spectral Width (-20dB)	$\Delta\lambda$	---	---	1	nm	
Side Mode Suppression Ratio	$SMSR$	30	---	---	dB	
Rise/Fall Time, (20–80%)	$T_{r, f}$	---	---	260	ps	
Relative Intensity Noise	RIN	---	---	-120	dB/Hz	
Total Jitter	TJ	---	---	227	ps	
Output Eye	Compliant with IEEE802.3z					
Max. P_{out} TX-DISABLE Asserted	P_{OFF}	---	---	-45	dBm	
Differential Input Voltage	V_{DIFF}	0.4	---	2.0	V	

■ **Receiver Electro-optical Characteristics**

$V_{CC} = 3.1\text{ V to }3.5\text{ V}, T_C = 0\text{ }^\circ\text{C to }70\text{ }^\circ\text{C} (-40\text{ }^\circ\text{C to }85\text{ }^\circ\text{C})$

PARAMETER	SYMBOL	MIN	TYP.	MAX	UNITS	NOTE
Optical Input Power-maximum	P_{IN}	-3	---	---	dBm	BER < 10^{-12}
Optical Input Power-minimum (Sensitivity)	P_{IN}	---	-27	-24	dBm	BER < 10^{-12}
Operating Center Wavelength	λ_C	1260	---	1610	nm	
Optical Return Loss	ORL	12	---	---	dB	
Signal Detect-Asserted	P_A	---	---	-24	dBm	
Signal Detect-Deasserted	P_D	-35	---	---	dBm	
Differential Output Voltage	V_{DIFF}	0.5	---	1.2	V	
Data Output Rise, Fall Time (20–80%)	$T_{r,f}$	---	---	0.35	ns	
Receiver Loss of Signal Output Voltage-Low	RX_LOS_L	0	---	0.5	V	
Receiver Loss of Signal Output Voltage-High	RX_LOS_H	2.4	---	V_{CC}	V	
Receiver Loss of Signal Output Voltage-High	RX_LOS_H	2.4	---	V_{CC}	V	



■ **Block Diagram of Transceiver**

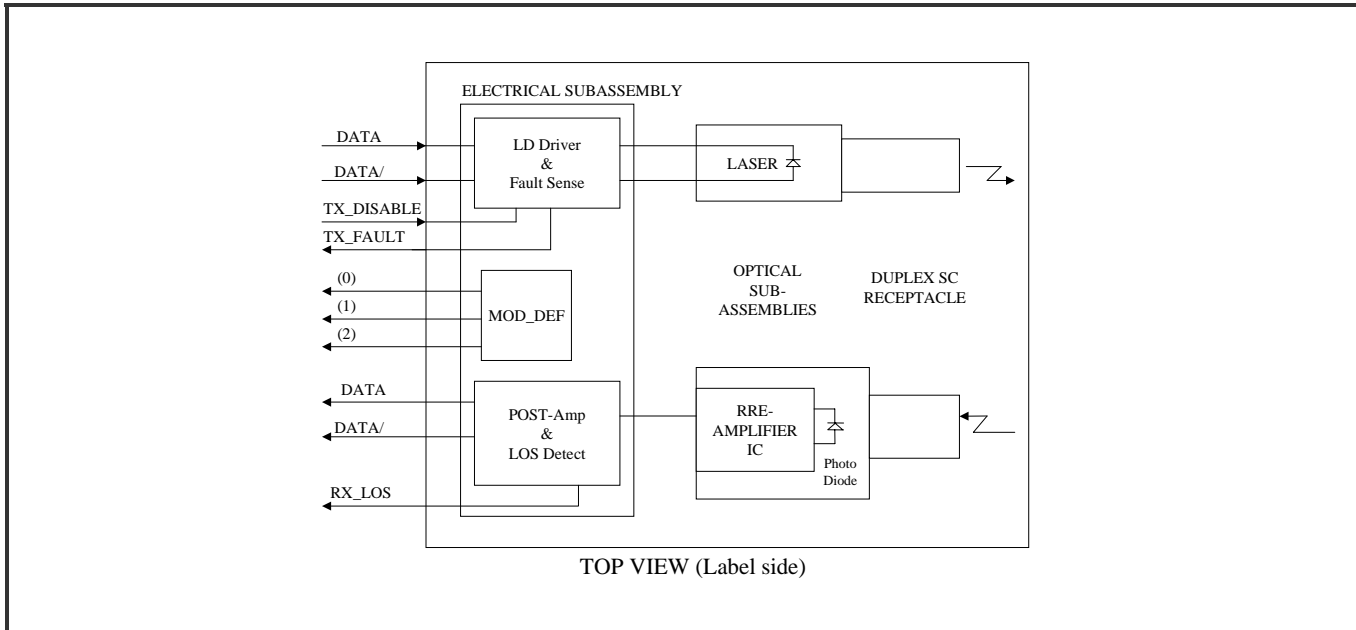

Transmitter Section

The transmitter section consists of a 1550 nm InGaAsP laser in an eye safe optical subassembly (OSA) which mates to the fiber cable. The laser OSA is driven by a LD driver IC which converts differential input LVPECL logic signals into an analog laser driving current.

TX_DISABLE

The TX_DISABLE signal is high (TTL logic “1”) to turn off the laser output. The laser will turn on when TX_DISABLE is low (TTL logic “0”).

Receiver Section

The receiver utilizes an InGaAs PIN photodiode mounted together with a trans-impedance preamplifier IC in an OSA. This OSA is connected to a circuit providing post-amplification quantization, and optical signal detection.

Receive Loss (RX_LOS)

The RX_LOS is high (logic “1”) when there is no incoming light from the companion transceiver. This signal is normally used by the system for the diagnostic purpose. The signal is operated in TTL level.

■ **Dimensions**

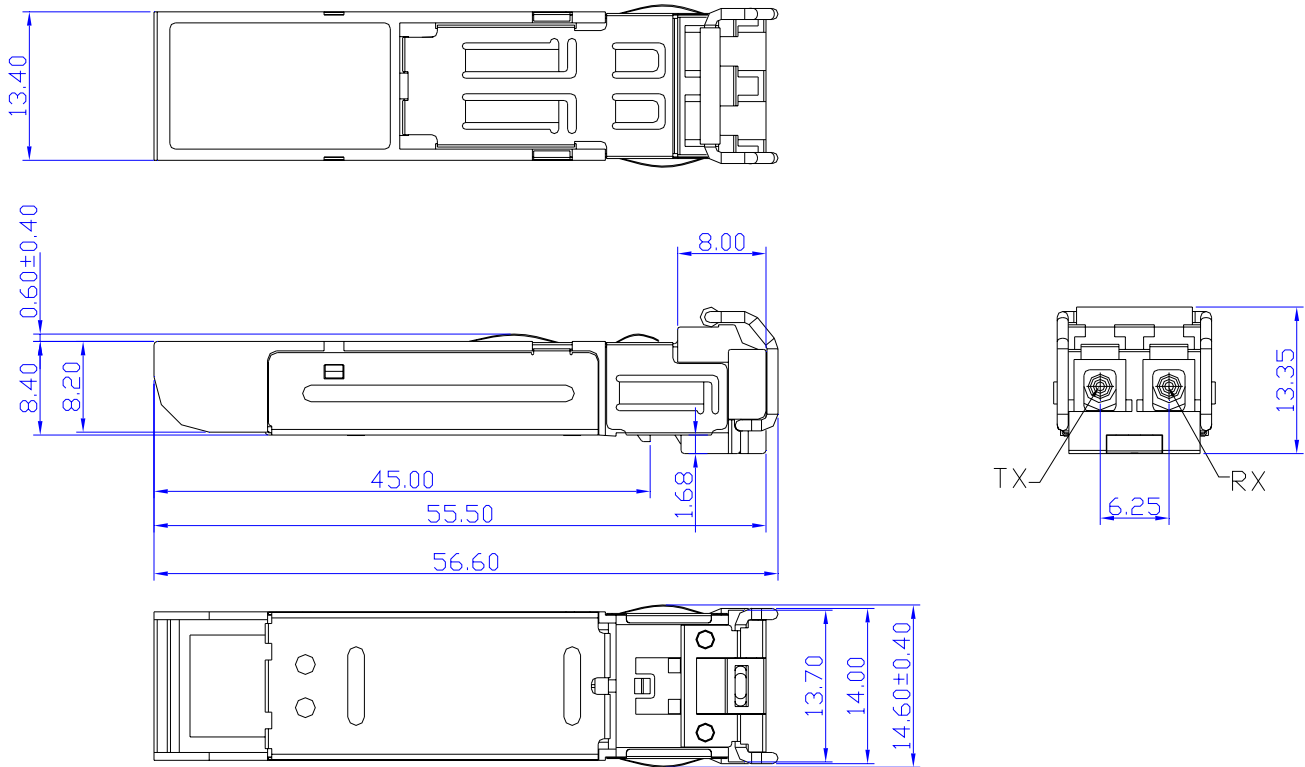

DIMENSIONS ARE IN MILLIMETERS

ALL DIMENSIONS ARE ± 0.2mm UNLESS OTHERWISE SPECIFIED

Unit: mm

■ SFP host board mechanical layout

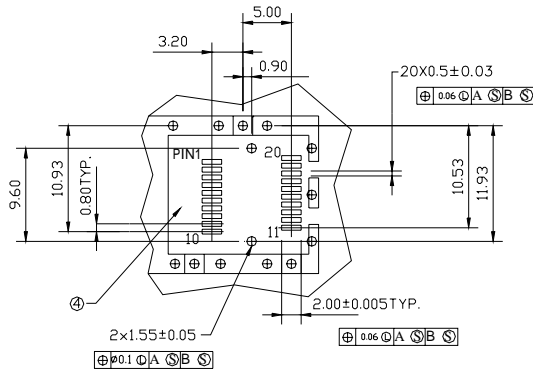
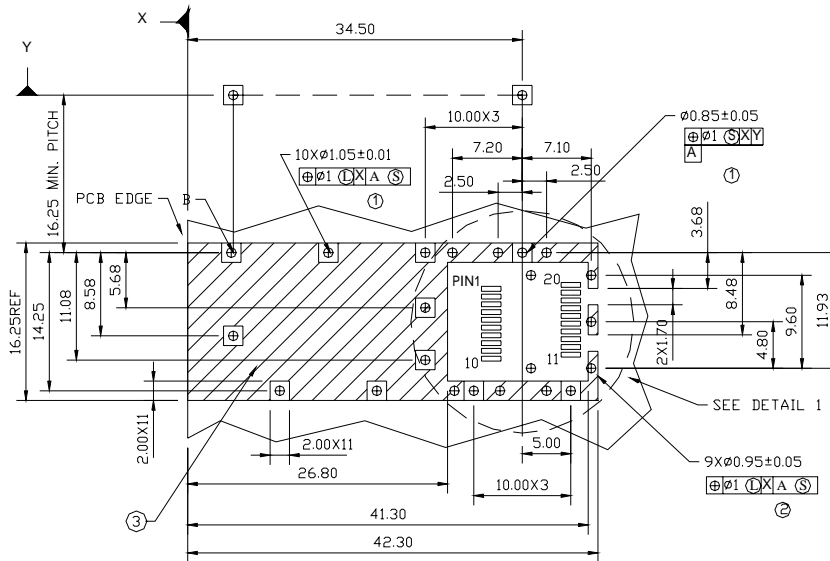

DETAIL 1

LEGEND

1. PADS AND VIAS ARE CHASSIS GROUND
2. THROUGH HOLES, PLATING OPTIONAL
3. HATCHED AREA DENOTES COMPONENT AND TRACE KEEPOUT (EXCEPT CHASSIS GROUND)
4. AREA DENOTES COMPONENT KEEPOUT (TRACES ALLOWED)

DIMENSIONS ARE IN MILLIMETERS

Unit: mm

■ **Assembly drawing**

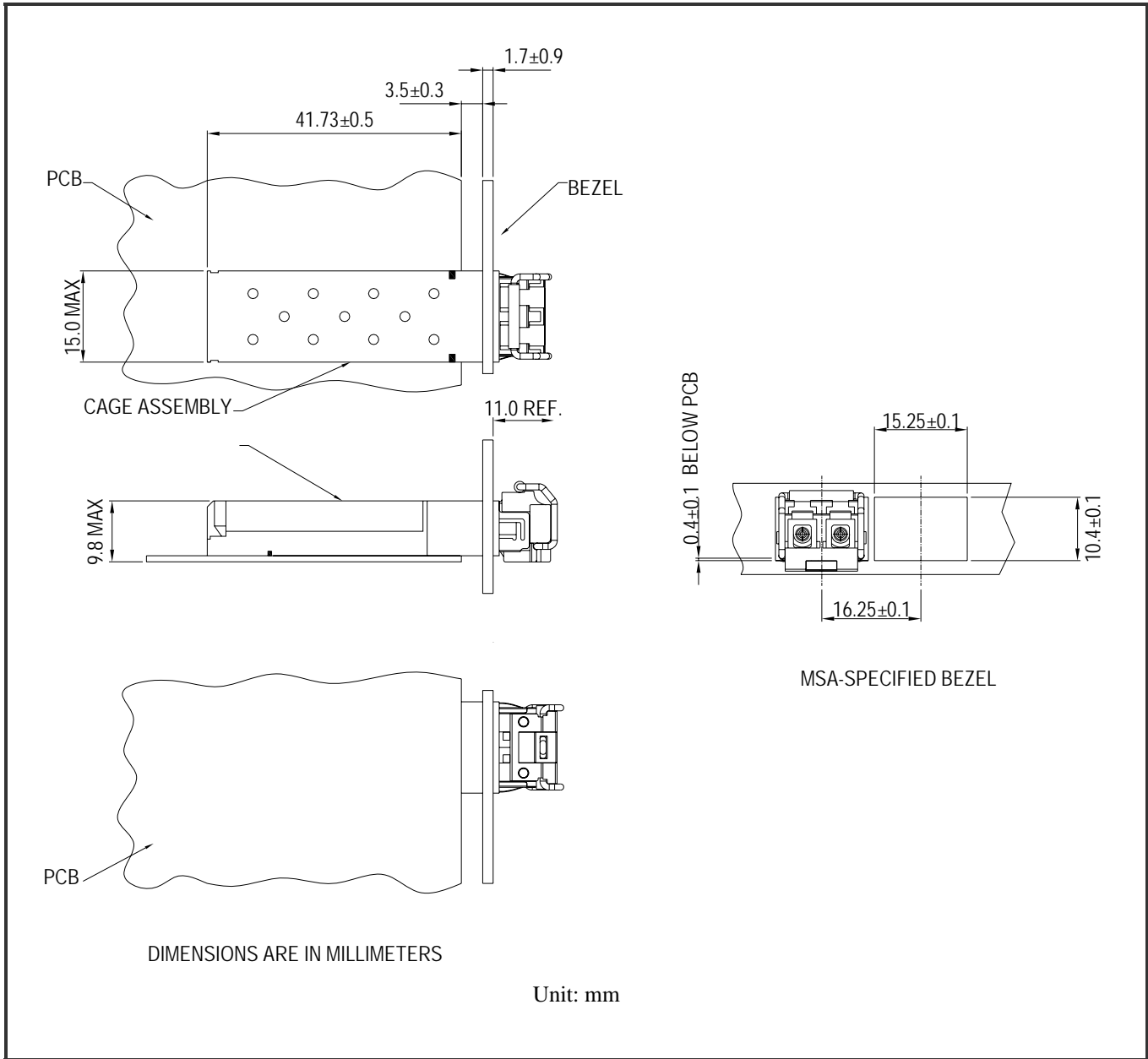

■ **Pin Assignment**

Pin-Out

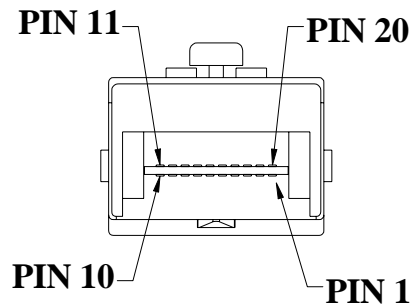

Pin	Signal Name	Description
1	T_{GND}	Transmit Ground
2	TX_FAULT	Transmit Fault
3	$TX_DISABLE$	Transmit Disable
4	$MOD_DEF (2)$	SDA Serial Data Signal
5	$MOD_DEF (1)$	SCL Serial Clock Signal
6	$MOD_DEF (0)$	TTL Low
7	$RATE_SELECT$	Open Circuit
8	RX_LOS	Receiver Loss of Signal, TTL High, open collector
9	R_{GND}	Receiver Ground
10	R_{GND}	Receiver Ground
11	R_{GND}	Receiver Ground
12	$RX-$	Receive Data Bar, Differential PECL, ac coupled
13	$RX+$	Receive Data, Differential PECL, ac coupled
14	R_{GND}	Receiver Ground
15	V_{CCR}	Receiver Power Supply
16	V_{CCT}	Transmitter Power Supply
17	T_{GND}	Transmitter Ground
18	$TX+$	Transmit Data, Differential PCEL, ac coupled
19	$TX-$	Transmit Data Bar, Differential PCEL, ac coupled
20	T_{GND}	Transmitter Ground



GBM-104-50 (RoHS compliant)
1550 nm Single-mode Transceiver, 20dB margin
Small Form Pluggable (SFP), 3.3V
1.0625Gbd Fiber Channel/1.25 Gigabit Ethernet

■ **Eye Safety Mark**

The GBM series singlemode transceiver is a class 1 laser product. It complies with EN 60825-1 and FDA 21 CFR 1040.10 and 1040.11. In order to meet laser safety requirements the transceiver shall be operated within the Absolute Maximum Ratings.

Caution

All adjustments have been done at the factory before the shipment of the devices. No maintenance and user serviceable part is required. Tampering with and modifying the performance of the device will result in voided product warranty.

Required Mark

Class 1 Laser Product
Complies with
21 CFR 1040.10 and 1040.11

Note : All information contained in this document is subject to change without notice.